

SDAD102

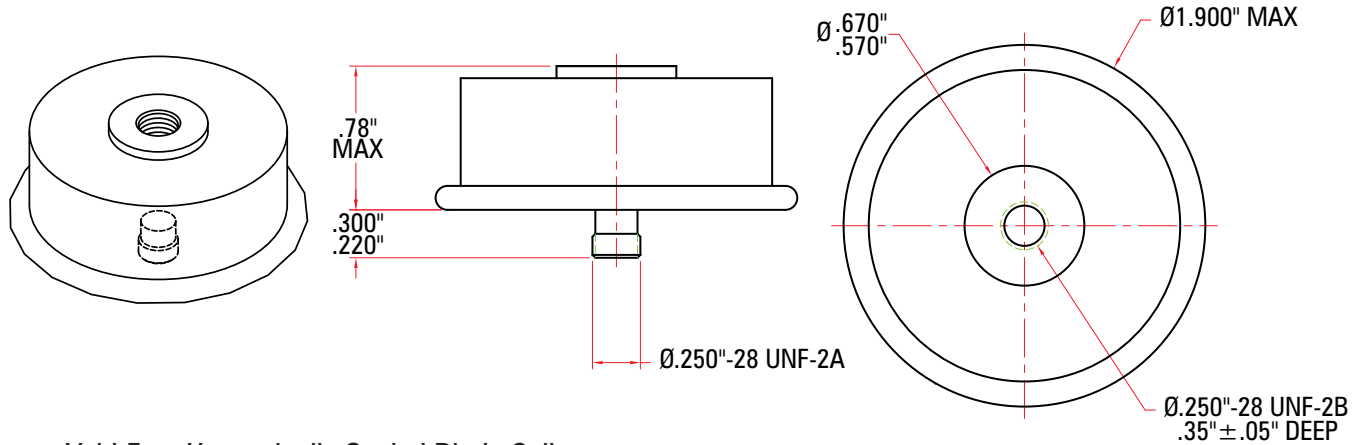

- Void-Free Hermetically Sealed Diode Cells
- Modular Design for Easy Stacking